

| REVISION RECORD | | | | |
|-----------------|--------|-------------|---------|----------|
| REV | ECN | DESCRIPTION | DRFT | DATE |
| △ | 0-0128 | 增加UL刻字及参数 | Lasting | 05.15.10 |

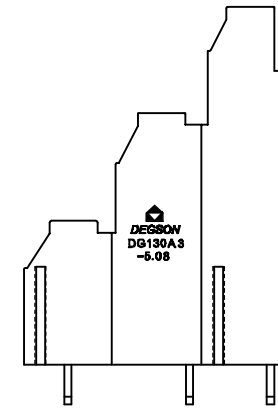
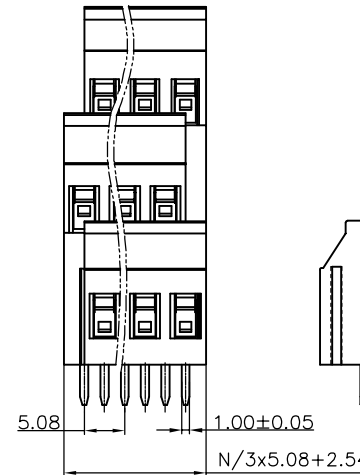
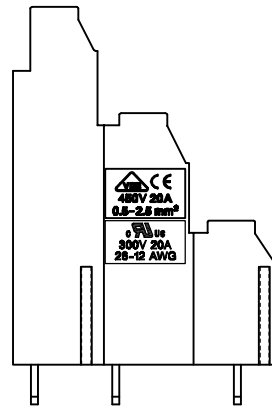
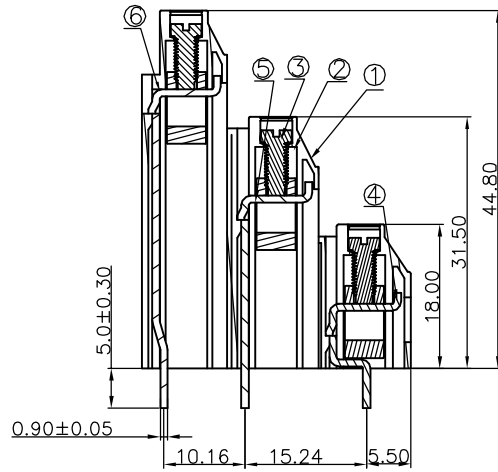
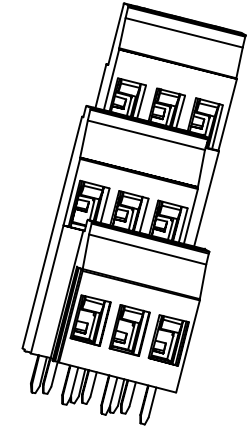
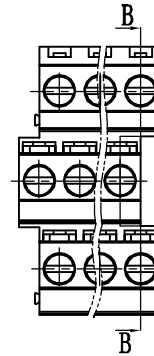
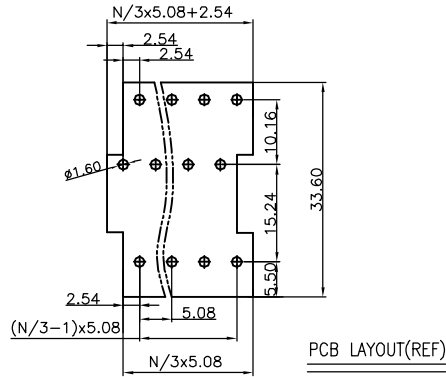

SECTION: B-B

Notes:

- Pitch: 5.08mm, Poles: 6-XXP
- Rated voltage/current: UL 300V/20A
IEC 450V/20A
- Operation temperatures: -40°C ~ +105°C
- Withstanding Voltage: AC2000V/1Min
- Insulation Resistance: 5000MΩ / DC1000V
- Wire Range: 26~12AWG, 0.2-2.5mm²
- Max. Torque Value: M3, 5.1kgf.cm
- Undimensioned Tolerances:

| Pitch range in mm | | Nominal dimension range in mm | | | | | | |
|-------------------|--------|-------------------------------|---------|---------|----------|----------|---------|--|
| | over 6 | over 10 | over 30 | over 60 | over 100 | over 150 | ∩ | |
| to 6 | to 10 | to 24 | to 30 | to 60 | to 100 | to 150 | ∇ | |
| ±0.10 | ±0.15 | ±0.25 | ±0.2 | ±0.3 | ±0.5 | ±0.7 | ±1.0 | |
| | | | | | | | 0.05/10 | |

| ITEM | NAME OF PART | NO. OF PART | Q'TY | MATERIAL | NOTES |
|------|----------------------|----------------|------|----------|---------------------|
| 6 | DG130A3-Pin header | 4138B00010 (H) | XX/3 | Copper | SnCe plated |
| 5 | DG130H-Pin header | 4125B00010 (H) | XX/3 | Copper | SnCe plated |
| 4 | DG130-Pin header | 4087B00010 (H) | XX/3 | Brass | SnCe plated |
| 3 | DG129-Screws-M3 | S000001430 (H) | XX | Steel | Cr ³⁺ Zn |
| 2 | DG129-Cage | X00000200 (H) | XX | Brass | Ni plated |
| 1 | DG130A3-5.08-Housing | 4138A0YXXA (H) | 1 | PA66 | UL94V-0 |

| | | | |
|----------------|----------------------------|-------------|----------------|
| DETACHED LISTS | MM (INCH) | DFTO LINDA | DATE 09/05/08* |
| | TOLERANCES EXCEPT AS NOTED | CHKD | DATE |
| | | MFO | DATE |
| | | APPVL | DATE |
| MM | ± | MATERIAL : | |
| .0 ± | ± | G.E : | |
| .00 ± | ± | FINISH : | |
| .000 ± | ± | SCALE : 1:1 | |
| ANGLES ± 1° | THIRD ANGLE PROJECTION | | |

DEGSON 宁波高正电子有限公司
DEGSON ELECTRONICS CO., LTD

NAME
DG130A3-5.08-XXP-1Y-00A(H)

DRAWING NO. DG130A3-5.08-E01 SIZE A3 REV T1 25/15/10*

/PART NO.

DO NOT SCALE DRAWING SHEET 1 OF 1